

ATLANTA

STRETCH

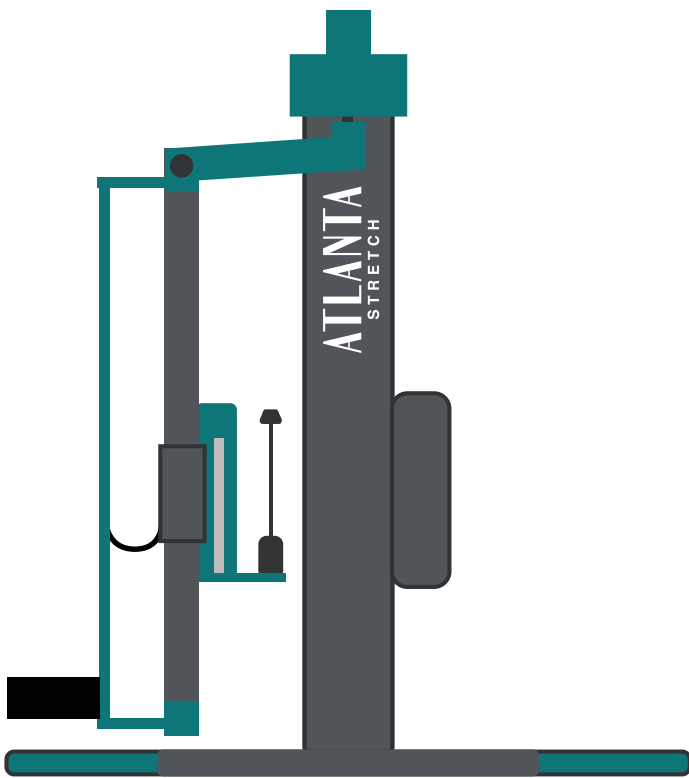

LYBRA

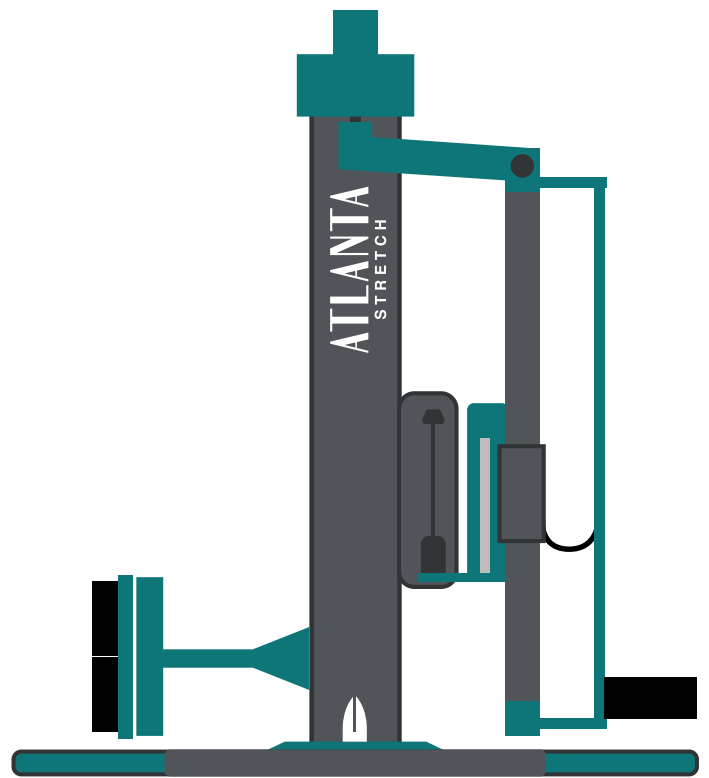

LYBRA AUTO

SEMI AUTOMATIC PALLET WRAPPER
MAINTENANCE FREE
EASY INSTALLATION

**Semi automatic turntable
for wrapping pallets with stretch film**

LYBRA

Input: 230 Volt
1 PHASE



LYBRA AUTO

Input: 230 Volt
1 PHASE



The operator loads the pallet and start the wrapping cycle. After this operation is completed, the machine cuts the film. The film remains held to the clamp, ready to wrap the next pallet. The entire cycle takes place completely automatically. The operator picks up the pallet at the end of the cycle.

PALLET DIMENSIONS

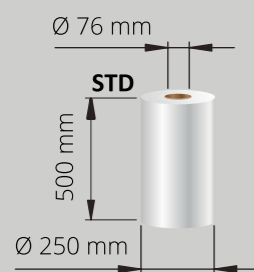

Max: 2000 Kg STD
Max: 3000 Kg OPT

Lybra
H = 2200 STD
H = 2500 OPT
H = 3000 OPT

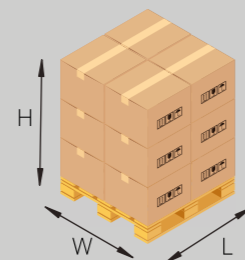

WxL mm	MAX Ø mm
1200x1200	1700 STD
1400x1400	1980 OPT
1500x1500	2120 OPT
1600x1600	2260 OPT
1700x1700	2400 OPT

APPLICATIONS



LYBRA STATION

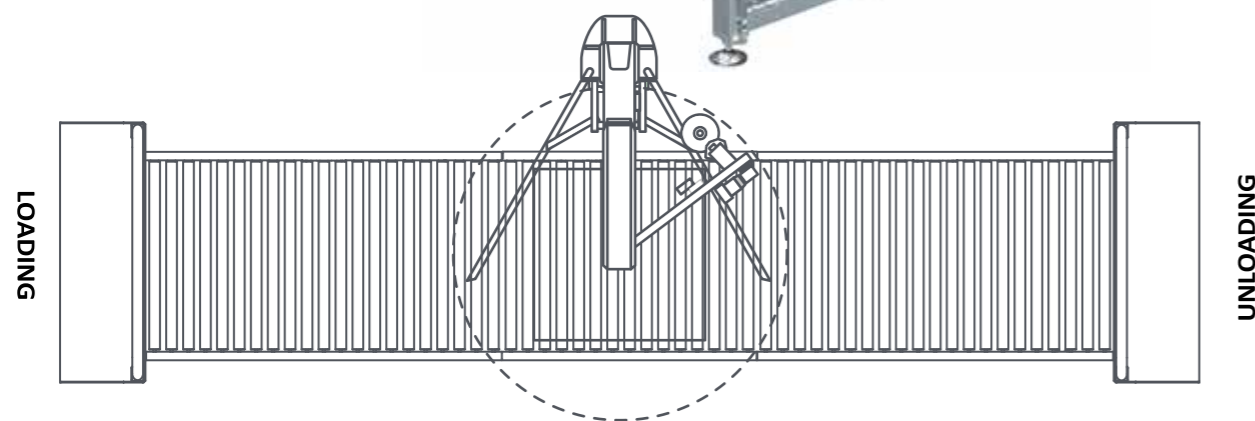

WRAPPING PROGRAMS

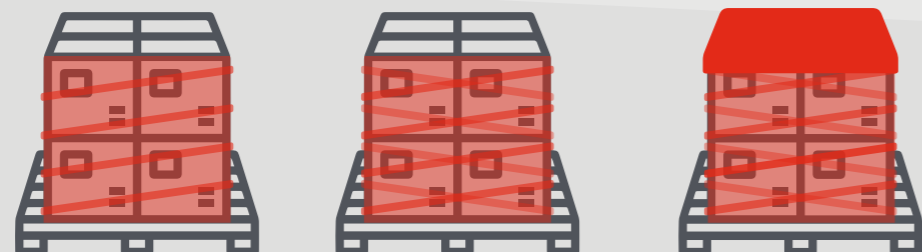

ATLANTA STRETCH SELLING POINTS

ERGONOMIC SOLUTION FOR THE USER

- IT** L'attenzione alla sicurezza e al massimo comfort del lavoratore contribuiscono a migliorare la qualità del lavoro, diminuendo lo stress a favore della soddisfazione generale dell'utente
- EN** For the highest security and safety of the user and to achieve a better working, and higher satisfaction of the user.
- FR** Pour la plus grande sécurité et sûreté de l'utilisateur et pour obtenir un meilleur environnement de travail et une plus grande satisfaction de l'utilisateur.
- DE** Für höchste Sicherheit des Nutzers, sowie zur Erreichung eines besseren Arbeitsumfelds und Zufriedenheit
- ES** Para la mayor seguridad y protección del usuario, mejor calidad de trabajo y una mayor satisfacción del usuario.



COMMERCIAL COMPONENTS AND INVERTERS AVAILABLE ON THE FREE MARKET

- IT** La facilità con cui i nostri componenti sono reperibili sul mercato contribuisce ad abbatterne il prezzo con notevole risparmio per l'utente.
- EN** The use of commercial components in all our products means higher reliability and lower costs but also flexibility in terms of spare parts.
- FR** La façon dont nous nous approvisionnons et spécifions des niveaux élevés pour les composants de nos produits, signifie que vous bénéficierez de niveaux de fiabilité élevés et constants
- DE** Der Einsatz handelsüblicher Komponenten in all unseren Produkten bedeutet höhere Zuverlässigkeit und geringere Kosten, aber auch Flexibilität bei der Materialversorgung.
- ES** El uso de componentes comerciales en todos nuestros productos significa mayor confiabilidad y menores costos, pero también flexibilidad en términos de suministro de repuestos.



POSSIBILITY TO ADJUST TENSION ON LOAD AND PRE STRETCH IN EVERY STEP OF THE WRAPPING CYCLE

- IT** I nostri carrelli offrono la possibilità di regolare in maniera mirata la tensione del film e il pre-stretch in ogni fase dell'avvolgimento.
- EN** Our carriages are standard equipped with the possibility to adjust film tension and pre-stretch during every phase of the wrapping process.
- FR** Nos chariots sont tous équipés en mode standard avec la possibilité de régler la tension du film et de le pré-étirer à chaque étape du processus d'emballage.
- DE** Unsere Folienschlitten sind so konzipiert, dass sowohl die Anlegespannung als auch die Folienvordehnung in jeder Phase des Wickelzyklus regulierbar sind.
- ES** Nuestros carros están equipados de serie con la posibilidad de ajustar la tensión de la película y preestirar durante cada fase del proceso de envoltura.



OPERATING PANEL



DISPLAY 11" easy to use touch screen

Lybra: 99 PROGRAMS

- IT** Pannello di controllo multifunzionale programmabile.
- EN** Multifunction programmable control panel.
- FR** Panneau de controle multifonction programmable.
- DE** Multifunktion programmierbare Systemsteuerung.
- ES** Panel de control programable multifuncion.

SPOOL FILM CARRIAGE

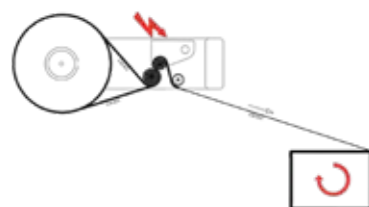

EASY FILM CHANGE

- IT** Cambio film semplificato, altezza di arresto del carrello porta bobina automatico.
- EN** Easy reel change, adjustable service height.
- FR** Changement de bobine facile, hauteur de service réglable.
- DE** Einfacher Folienwechsel in ergonomischer Arbeitshöhe.
- ES** Cambio fácil de bobina, altura de servicio ajustable.

FE

- IT** Frizione elettromagnetica regolabile da pannello comandi.
- EN** Electromagnetic friction adjustable from control panel.
- FR** Frein électromagnétique réglable depuis le panneau de commande.
- DE** Elektromagnetische Bremse auf Umlenkwalze vom Bedienpult instellbar.
- ES** Fricción electromagnética regulable desde el panel de comandos.

PRS POWER ROLLER STRETCH

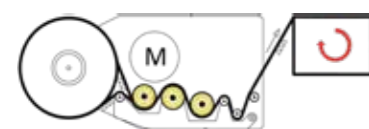

- IT** Sistema di prestiro motorizzato a 3 rulli comandato elettronicamente con rapporti intercambiabili: 150- 200- 250%.
- EN** Motorized pre-stretch system with 3 driven rollers electronically controlled with interchangeable ratios: 150- 200- 250%.
- FR** Système de pré-étirage motorisé et asservi à 3 rouleaux, rapports interchangeables: 150- 200- 250%.
- DE** Angetriebener Vordehnssystem mit 3 Vordehnrollen, elektronisch gesteuert mit leicht wechselbarer Zahnradsätzen: 150- 200- 250%.
- ES** Sistema de prestiro motorizado con 3 rodillos, comandado electrónicamente con valores intercambiables: 150- 200- 250%.

PS POWER STRETCH

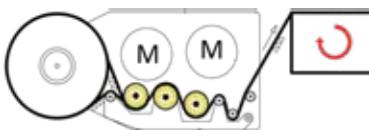

- IT** Sistema di motorizzato a 3 rulli con 2 motori e variazione da 120 a 350% regolabile da quadro comandi.
- EN** Motorized pre-stretch system with 3 driven rollers and 2 motors adjustable between 120 to 350% from control panel.
- FR** Système de pré-étirage motorisé et asservi à 3 rouleaux et 2 moteurs, rapport ajustable de 120 à 350% depuis le panneau de commande.
- DE** Angetriebener Vordehnssystem mit 3 Vordehnrollen und 2 Motoren, stufenlos regelbare Werte zwischen 120 und 350% von Bedienpult.
- ES** Sistema de prestiro motorizado con 3 rodillos y 2 motores, regulable de 120 a 350% desde el panel de comandos.

MEANS OF LOADING

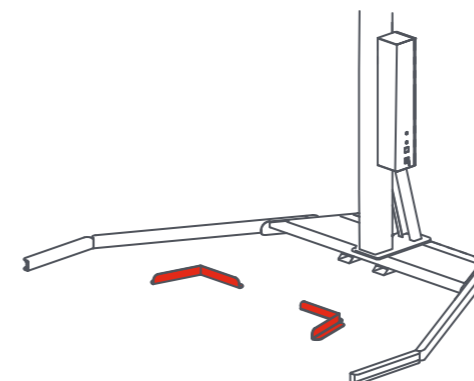

OPTIONAL

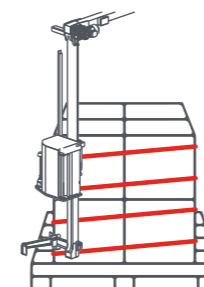
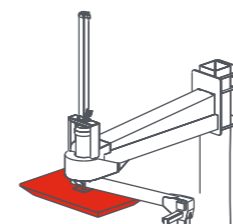
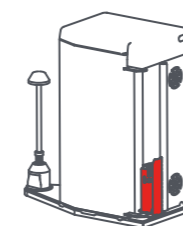

FLOOR MOUNTED GUIDES

- IT** Guida per centraggio automatico dei pallets.
- EN** Floor mounted guides to locate the pallet correctly are included.
- FR** Support de guidage pour une parfaite lecture de palette sont inclus.
- DE** Zum Lieferumfang gehört ebenfalls eine Palettenpositionierhilfe welche zeitgleich eine Kollision mit dem Dreharm ausschließt.
- ES** Soporte de guía para cargar correctamente la plataforma, incluidos en la entrega.

AUTOMATIC FILM CUT FOR FE AND OPRS CARRIAGES

- IT** Sistema di taglio automatico del film a fine ciclo.
- EN** Automatic Film cutting Device at cycle end.
- FR** Coupe automatique du film.
- DE** Automatische Folienschneidvorrichtung am Zyklusende.
- ES** Sistema automatico de corte del film al fin del ciclo.

TOP PRESSURE UNIT

- IT** Pressore tenuta pallet.
- EN** Pallet holder presser.
- FR** Plateu stabilisateur de charge.
- DE** Palettendruchalter.
- ES** Prensor de retencion del palet.

ROPING SYSTEM

- IT** Sistema di cordonatura film: Permette di ridurre l'altezza del film formando un cordone che assicura una più efficiente stabilizzazione del carico.
- EN** Roping System: Reducing the film width to form a rope to ensure more effective load stabilisation.
- FR** Systeme permettant de réduire la laize du film en formant un cordon qui assure une meilleure stabilisation de la charge.
- DE** Schnurrvorrichtung: Reduzierung der Folienbreite zur Schnur um eine bessere Stabilisierung der Ladung zu gewährleisten.
- ES** Sistema de Cordón: permite reducir el ancho del film formando un cordón que asegura eficientemente la estabilidad de la carga.

LOW TEMPERATURE MACHINE

- 5°C coldstore version • -30°C freezer version • inox version

SEMI AUTOMATIC RANGE

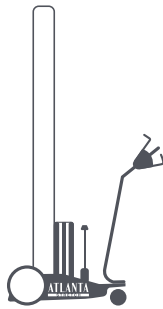

MARATHON

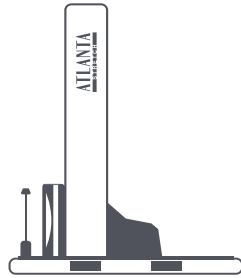

EVA

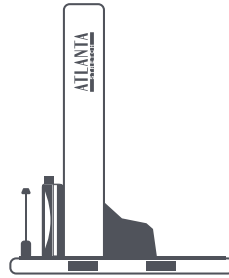

SYNTHESI

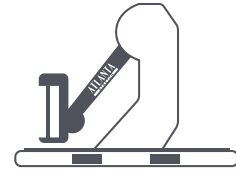

MYTHO ARM

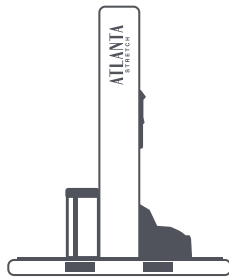

MYTHO S



SFERA

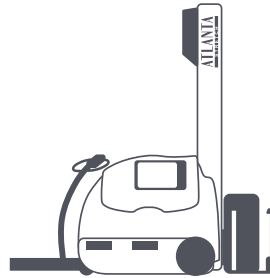

SFERA MAST



NEOS

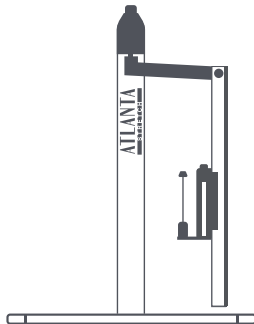

LYBRA EASY

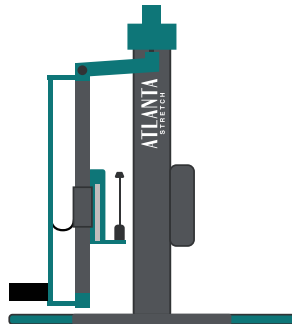

LYBRA

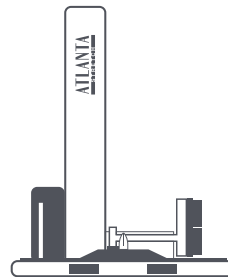

MYTHO AUTO

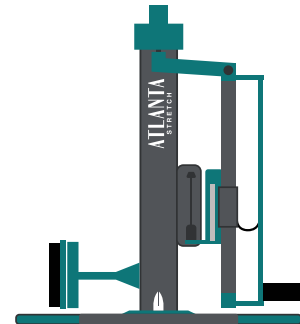

LYBRA AUTO

Atlanta Stretch Authorized dealer

ATLANTA

STRETCH

turning business around

Headquarter: Atlanta Stretch Italy Spa

Subsidiaries: Atlanta Stretch Australia - Atlanta Stretch China - Atlanta Stretch Deutschland - Atlanta Stretch France - Atlanta Stretch Iberica - Atlanta Stretch India - Atlanta Stretch Mexico - Atlanta Stretch Russia - Atlanta Stretch SEA - Atlanta Stretch Sweden - Atlanta Stretch Turkey - Atlanta Stretch UK



View all optional tools here

www.atlantastretch.com

Find out all our dealers

