

SEMI AUTOMATIC

MYTHO

MAINTENANCE FREE MACHINES
EASY TO BE INSTALLED

Atlanta Stretch S.p.A - Italy
Atlanta Deutschland GmbH
Atlanta Iberica - Spain
Atlanta Packaging Ltd - UK
Atlanta France Sarl
Atlanta Stretch Australia
Atlanta Stretch Russia

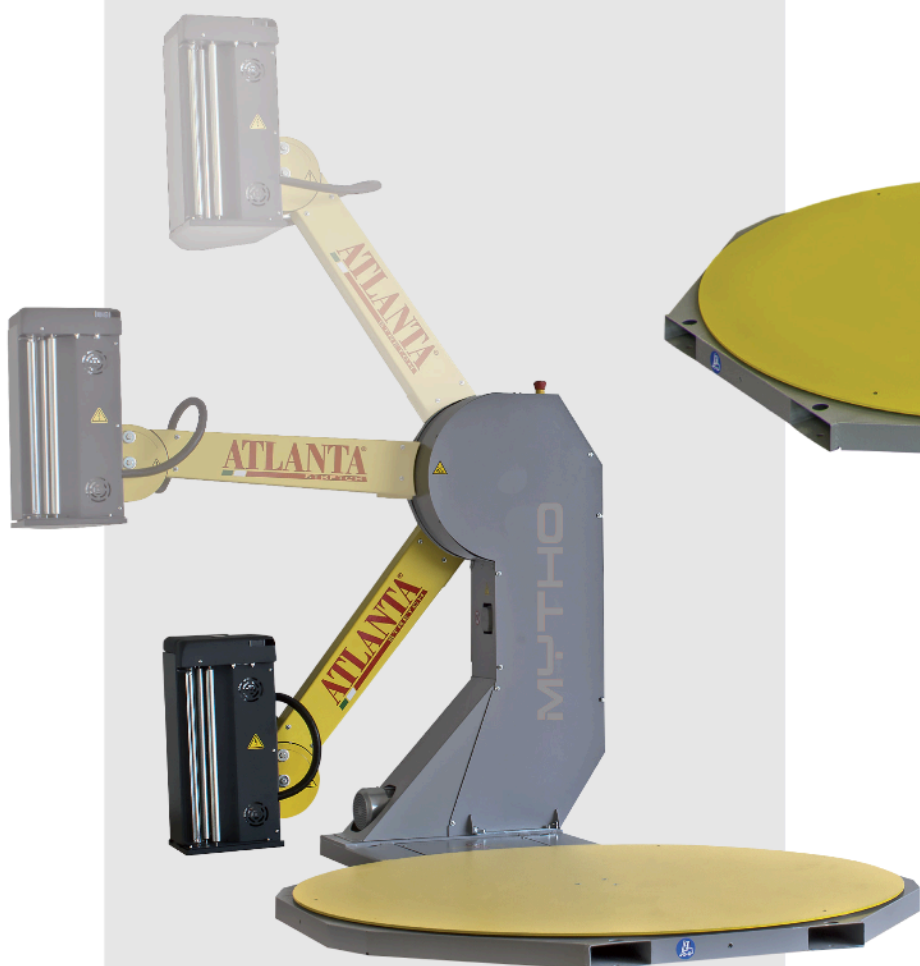

ATLANTA

S T R E T C H

stretch wrapping machines specialist



www.atlantastretch.com

IT_ Tavola rotante di nuova generazione per avvolgere carichi palletizzati di qualsiasi forma e peso con film estensibile anche macroforato.

EN_ New design turntable for wrapping palletised loads of any shape and weight with stretchable film, including macro-holed film.

FR_ Table tournante de dernière génération pour filmer les charges palettisées avec du film étirable plein ou macro perforé.

DE_ Stretchwickler der neuen Generation zum Wickeln von Ladungen unterschiedliche Formen und Gewichte mit Stretchfolien oder gelochte Stretchfolien.

ES_ Mesa rotante de nueva generación para envolver cargas paletizadas de cualquier forma y peso, con film extensible y macro perforado.

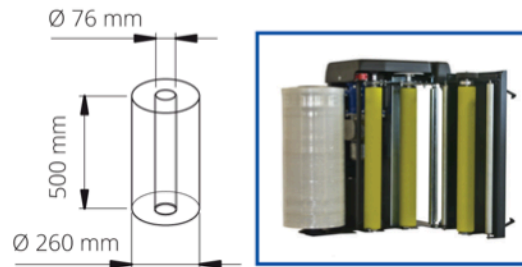

Pallet dimension

- Ø 1500 max 800x1200 mm
- Ø 1650 max 1000x1200 mm
- Ø 1800 max 1200x1200 mm
- Ø 2200 max 1500x1500 mm
- Ø 2400 max 1650x1650 mm

IT_ Minimo ingombro, trasporto facile, costi di gestione ridotti.

EN_ Small footprint, easy transport, reduced operating costs.

FR_ Faible encombrement, transport facile, coûts d'exploitation réduits.

DE_ Geringer Platzbedarf, einfachen Transport, Senkung der Betriebskosten.

ES_ Ocupa poco espacio, fácil transporte, reducción de los costos de operación

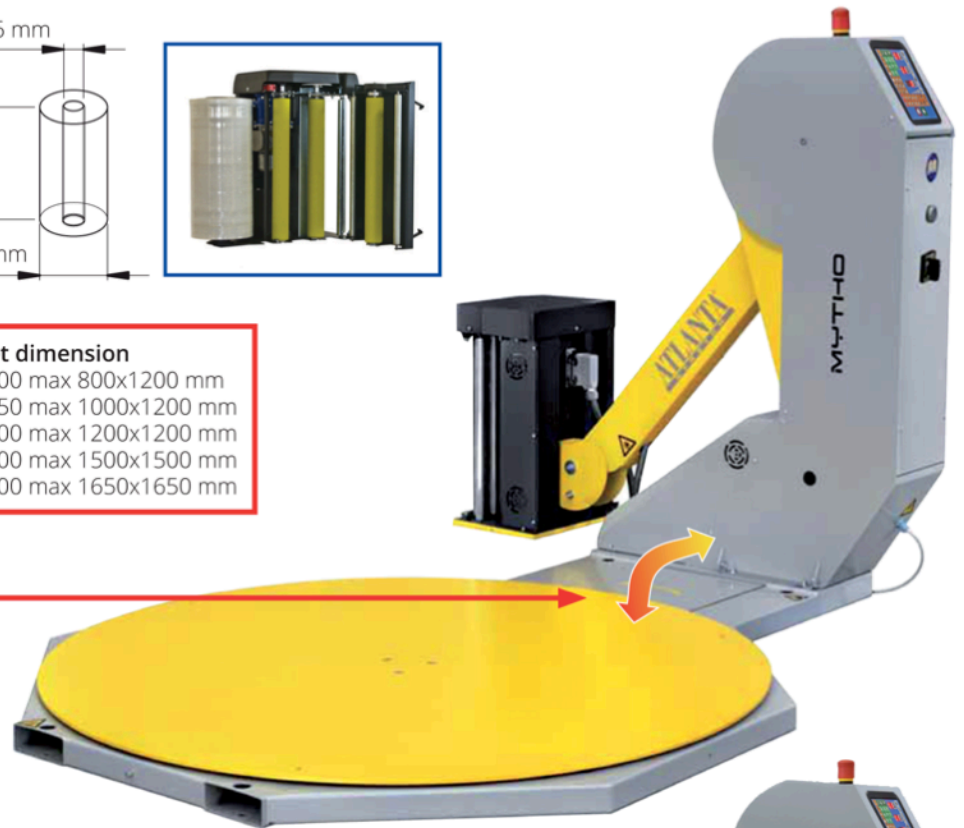

MYTHO TP

IT_ Versione transpallet.

EN_ Transpallet version.

FR_ Version transpalette.

DE_ Ausführung Transpallet.

ES_ Version transpalet.

Pallet
Max weight 1200 kg

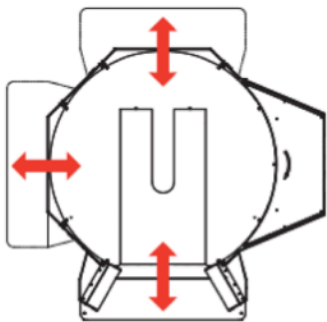

MYTHO / MYTHO EASY

IT_ Con Mytho / Mytho-Easy (facile da usare), si completa la gamma di macchine, questa versione si caratterizza per le funzioni semplificate. Pannello di controllo multifunzione programmabile.

EN_ The easy-to-use Mytho-Easy completes our range of machines; this version features simplified operation. Multifunction programmable control panel.

FR_ Mytho-Easy (utilisation facile) se caractérise pour l'utilisation et l'application de film pré-étiré et par ses fonctions simples mais complètes. Panneau de contrôle multifonction programmable.

DE_ Mytho-Easy (Einfach zum Bedienen) ergänzt die Baureihe der Stretchwickler, das Merkmal dieses Modell ist die Vereinfachung der Funktionen. Multifunktion programmierbare Systemsteuerung.

ES_ Con Mytho-Easy (facil da usar), se completa la gama de maquinas, esta versión se caracteriza por las funciones simplificadas. Panel de control programable multifunción.



Display touch-screen 11"
easy to use
(version Mytho / Mytho Easy)

Pallet
Max weight 2000 kg



FM

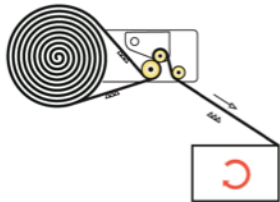

IT_ Freno meccanico regolabile manualmente
EN_ Mechanical brake manually adjustable.
FR_ Frein mécanique sur rouleau de détour ajustable manuellement.
DE_ Mechanische Bremse auf Umlenkwalze.
ES_ Fricción mecánica regulable manualmente.

FE



IT_ Frizione elettromagnetica regolabile da pannello comandi.
EN_ Electromagnetic friction adjustable from control panel.
FR_ Frein électromagnétique réglable depuis le panneau de commande.
DE_ Elektromagnetische Bremse auf Umlenkwalze vom Bedienpult einstellbar.
ES_ Fricción electromagnética regulable desde el panel de comandos.

PRS POWER ROLLER STRETCH

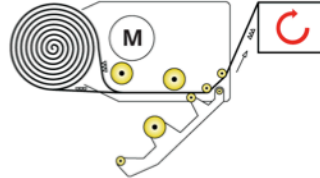

IT_ Sistema di prestiro motorizzato a 3 rulli comandato elettronicamente con rapporti intercambiabili: 150 - 200 - 250%.
EN_ Motorized pre-stretch system with 3 driven rollers electronically controlled with interchangeable ratios: 150 - 200 - 250%.
FR_ Système de pré-étirage motorisé et asservi à 3 rouleaux, rapports interchangeables: 150 - 200 - 250%.
DE_ Angetriebener Vordehnssystem mit 3 Vordehnrollen, elektronisch gesteuert mit leicht wechselbarer Zahnradsätzen: 150 - 200 - 250%.
ES_ Sistema de prestiro motorizado con 3 rodillos, comandado electrónicamente con desarrollos intercambiables: 150 - 200 - 250%.

PS POWER STRETCH

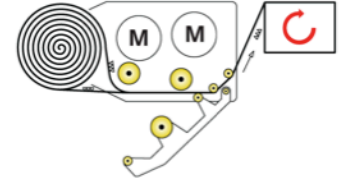

IT_ Sistema di prestiro motorizzato a 3 rulli con 2 motori e variazione continua da 120 a 350% regolabile da quadro comandi.
EN_ Motorized pre-stretch system with 3 driven rollers and 2 motors adjustable between 120 to 350% from control panel.
FR_ Système de pré-étirage motorisé et asservi à 3 rouleaux et 2 moteurs, rapport ajustable de 120 à 350% depuis le panneau de commande.
DE_ Angetriebener Vordehnssystem mit 3 Vordehnrollen und 2 Motoren, stufenlos regelbare Werte zwischen 120 und 350% von Bedienpult.
ES_ Sistema de prestiro motorizado con 3 rodillos y 2 motores, regulable da 120 a 350% desde el panel de comandos.

MYTHO / MYTHO EASY / MYTHO TP

TECHNICAL CHARACTERISTICS

Total installed power	1.75 Kw
Standard input voltage	230V mono-phase - 50/60 Hz
Electrical system and motors protection	IP 54
Standard pallet height	2400 mm (with Mast 2500 mm)
Optional pallet height	3000 mm / 3300 mm / 3700 mm
Max loading weight	2000 Kg (TP 1200 Kg)
Table diameter	1650 mm / 1800 mm / 2200 mm / 2400 mm

OPTIONAL



- IT_ Pressore tenuta pallet.
- EN_ Pallet holder presser.
- FR_ Plateau stabilisateur de charge.
- DE_ Palettendruckhalter.
- ES_ Prensor retención palet.

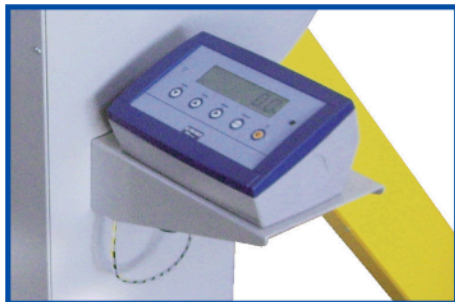

- IT_ Sistema di pesatura integrato.
- EN_ Integrated weighing systems.
- FR_ Pesage intégré.
- DE_ Integrierte Waagesysteme.
- ES_ Sistema integrado de pesaje.



- IT_ Sistema d'imballo per porte e finestre.
- EN_ Wrapping System for doors and windows.
- FR_ Système d'emballage pour portes et fenêtres.
- DE_ Wickelsysteme für Fenster und Türen.
- ES_ Sistema de embalaje para puertas y ventanas.



- IT_ Colonna per carichi fino a 3700 mm.
- EN_ Mast for loads up to 3700 mm high.
- FR_ Colonne pour charges jusqu'à 3700 mm.
- DE_ Mast für Ladungen bis 3700 mm hoch.
- ES_ Columna para cargas de hasta 3700 mm.



- IT_ Controllo peso film.
- EN_ Film weight check.
- FR_ Calcul poids de film.
- DE_ Kontrolle Foliengewicht.
- ES_ Control peso film.

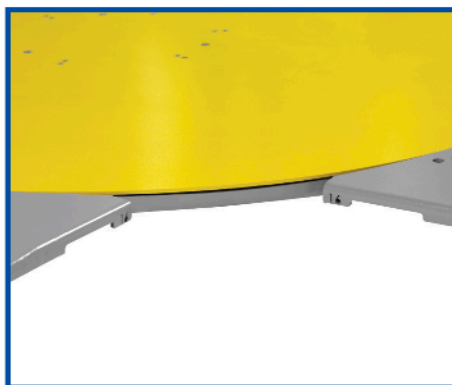

- IT_ Basamento basso profilo per transpallet manuale.
- EN_ Low profile basement for manual lifter.
- FR_ Châssis extra fin pour transpalette manuel.
- DE_ Flaches Drehtellergestell für Handhubwagen.
- ES_ Base con perfil bajo especial para transpaletas.

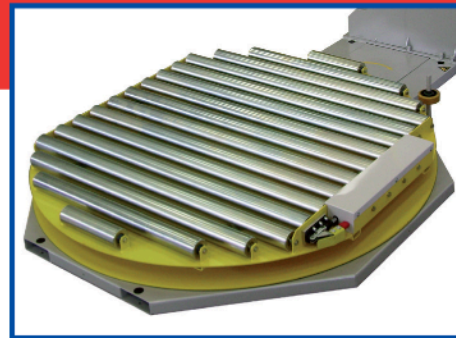

- IT_ Rulliera non motorizzata.
- EN_ Non-motorized roller conveyor.
- FR_ Non-motorisés à rouleaux.
- DE_ Nicht-Motorisierte Rollenbahn.
- ES_ Rodillos no motorizados.



- IT_ Rampa di carico.
- EN_ Loading ramp.
- FR_ Rampe.
- DE_ Ladungsrampe.
- ES_ Rampa de carga.

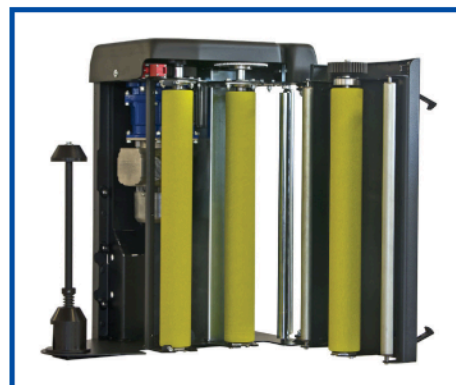

- IT_ Inserisco il film estensibile con facilità e ne consumo poco. Sistema di taglio automatico del film a fine ciclo.
- EN_ I easily insert stretch film and I use it economically. Automatic Film cutting device at cycle end.
- FR_ Facilité de passage du film en sécurité et consommation réduite. Coupe automatique du film.
- DE_ Schnelle Einführungs-system und sparsame Verbrauch von Stretchfolien. Automatische Folienschneidvorrichtung am Zyklusende.
- ES_ Introducción del film extensible con facilidad y reducido tiempo. Sistema automático de corte film con fin de ciclo.

Atlanta Stretch S.p.A.
 Via Chiesa di Camerano, 30
 47824 Poggio Torriana (Rimini) Italia
 Tel. +39 0541 627145
 Fax +39 0541 627220
 www.atlantastretch.com
 sales@atlantastretch.com

ATLANTA

S T R E T C H

stretch wrapping machines specialist